







20 700 360



- 135mm projection
- fixed spout
- circular, air-enriched flow
- height of mixer 72 mm
- height up to aerator 40 mm
- hole diameter valve 32 mm
- hole diameter spout 35 mm
- without rosette
- 2x 1/2" x 1/2" high pressure hose
- max. flow 7 l/min
- lead-free
- This product can help a building meet the requirements of Green Building Rating Systems, e.g. LEED®, BREEAM®, DGNB

Only suitable for basins with an overflow.

	Platinum	20 700 360-08
	Chrome	20 700 360-00
	Brushed Platinum	20 700 360-06
	Durabress (23kt Gold)	20 700 360-09
	Brushed Durabress (23kt Gold)	20 700 360-28
	Brushed Dark Platinum	20 700 360-99

Recommended miscellaneous



High pressure hoses - 12 506 970 90
 • 2x 3/8" x 1/2" x 500mm high pressure hose

20 700 360

mm [inches]

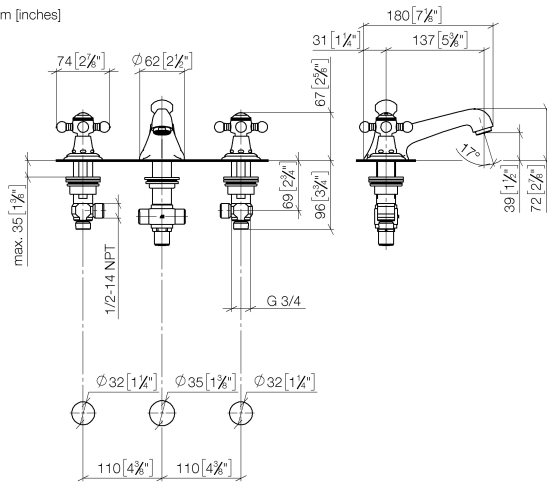

Flow rate chart



Certificates

GDV_0400288.

ETA_17861.

WRAS_1512009.

LGA_8027.

20 700 360

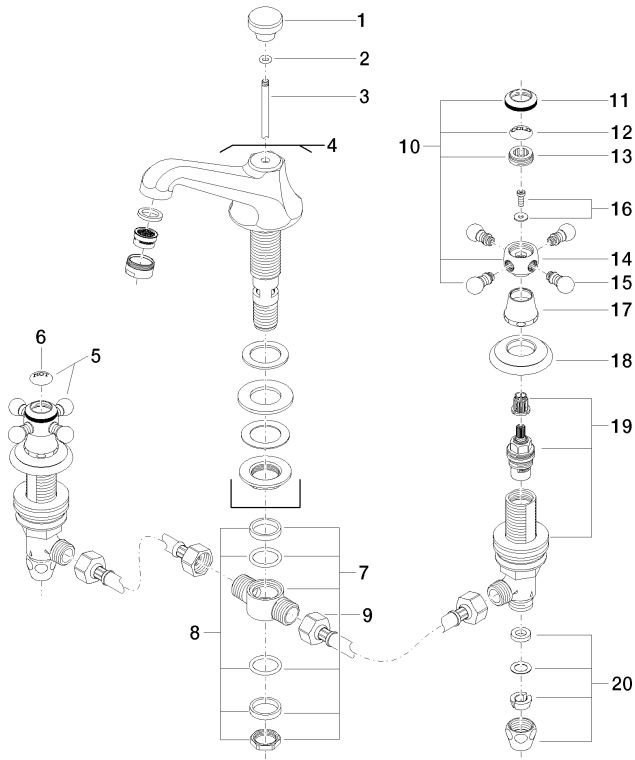

21 ————— Ablaufgarnitur 04.11.01.001.00.FP